



## System Overview

# LAMTEC GFI Ignition and Pilot Burner

# SIL 3 Flame Monitoring Device F130I.



CE 0085

Gas Appliances Directive 2009/142/EC, CE0085



CE 0036

Pressure Equipment Directive 2014/68/EU, CE0036



SIL 3

SIL 3 Confirmation, DIN EN 61508 Parts 1-7

# LAMTEC GFI Pilot Burner Series - A New Generation

For more than 20 years LAMTEC has been synonymous for German quality, innovation, design and manufacturing excellence. A new series of ignition/pilot burners is now being added to the highly successful burner management, flue gas analyser and flame detection product ranges.

Pilot burners are used as an ignition source in many segments of the combustion industry including industrial furnaces and boilers, power generation, and oil and gas processing. The GFI range of ignition/pilot burners will be supplied as standard with an integrated ignition transformer and ionisation flame detector, both of which are SIL 3 certified and EC type approved.

Based on a modular design the GFI can be flexibly configured to meet varying customer application requirements. Replacement cost and maintenance down-time are also reduced.

The rugged aluminium enclosure which houses the ionisation flame scanner and ignition transformer is IP65 in the standard and can be used almost everywhere. With all the operational components fully integrated and with SIL 3 rating the GFI provides a reliable, secure and up-to-date solution for a wide range of application needs.

In its standard version the GFI is approved for continuous operation.

## Advantages:

- Low pressure loss through flow optimisation
- Immediate, repeatable and reliable ignition at every firing rate
- Highest flame stability
- Ionisation flame monitoring for continuous operation
- Modular design
- Approved for use in SIL 3 system
- Marine climate resistant aluminium housing or stainless steel type
- Protection class IP65
- Thermal power up to 3,000 kW
- Flame length up to 3,000 mm
- Pilot burner length up to 6,000 mm
- Fuel: natural gas, LPG (liquid propane gas), coke gas, refinery gas
- Individually customised solutions

### Example GFI 48:

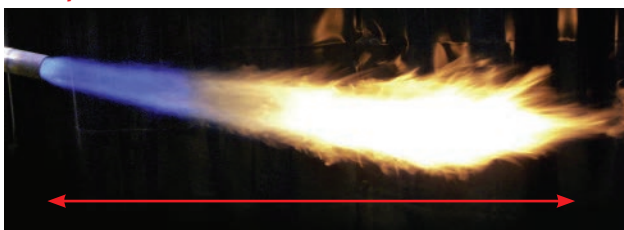

Type	Flame length with LPG
GFI 48	approx. 1.300 mm

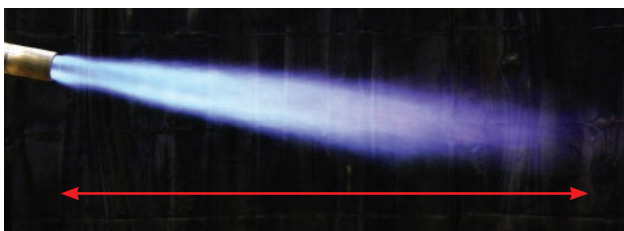

Type	Flame length with natural gas
GFI 48	approx. 750 mm

### Example GFI 70 / GFI 89:

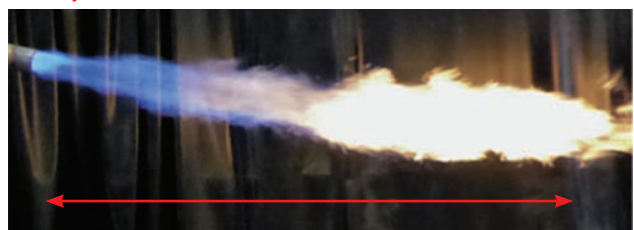

Type	Flame length with propane
GFI 70	approx. 2.000 mm
GFI 89	approx. 3.000 mm



Type	Flame length with natural gas
GFI 70	approx. 1.200 mm
GFI 89	approx. 2.500 mm

# Installation GFI 48.

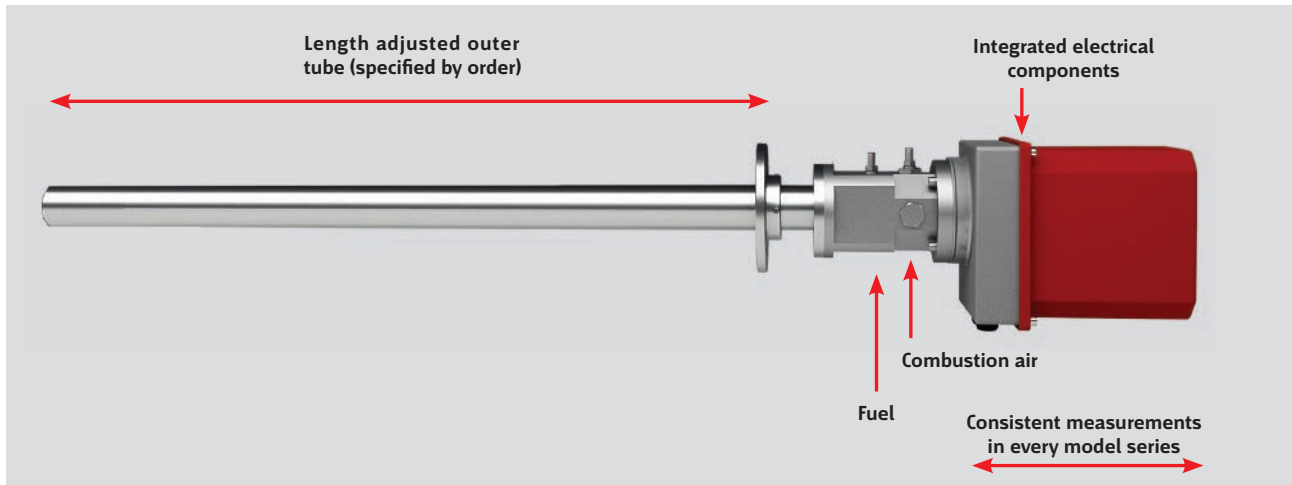

## GFI 48 Set flame quality and flame stability

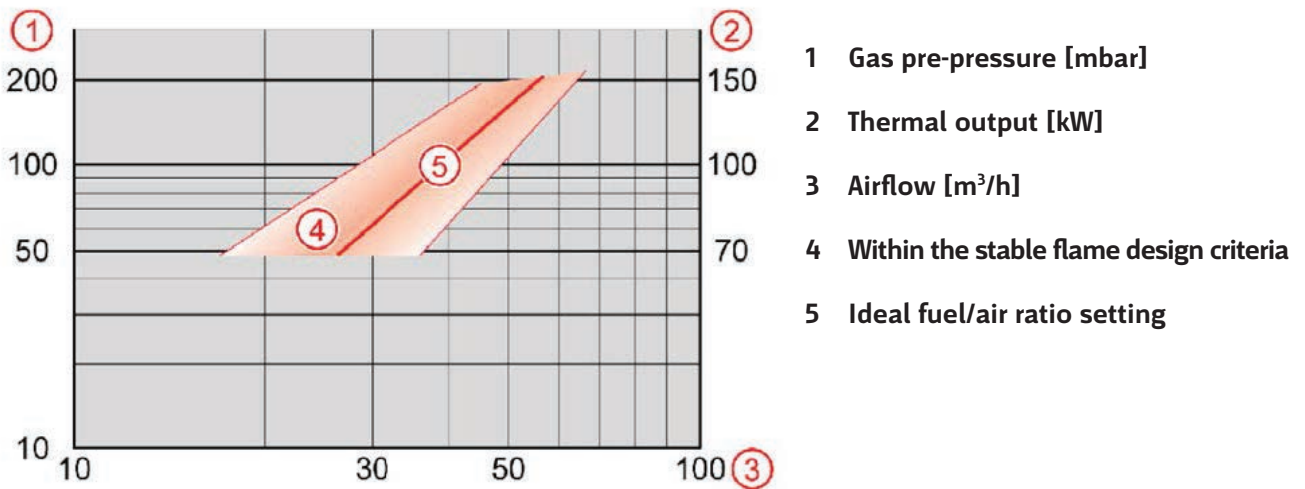

	Standard
Tube diameter	48.3 mm x 2 mm
Mounting flange	Slide flange (e.g. DN 50, PN 6)
Thermal power	70 kW - 150 kW
Flame length	Up to 800 mm
Gas connection	1/2" BSPP internal thread
Fuel gas volume flow	15 Nm³/h Natural gas (@ 200 mbar) 6 Nm³/h Propane (@ 200 mbar)
Air connection	1" BSPP internal thread
Air volume flow	60 Nm³/h (@ 15 mbar) for max. heat release. Lower air flow required if lower gas flow is used. Additional air for stoichiometric combustion must be available in the combustion chamber

# GFI 70.

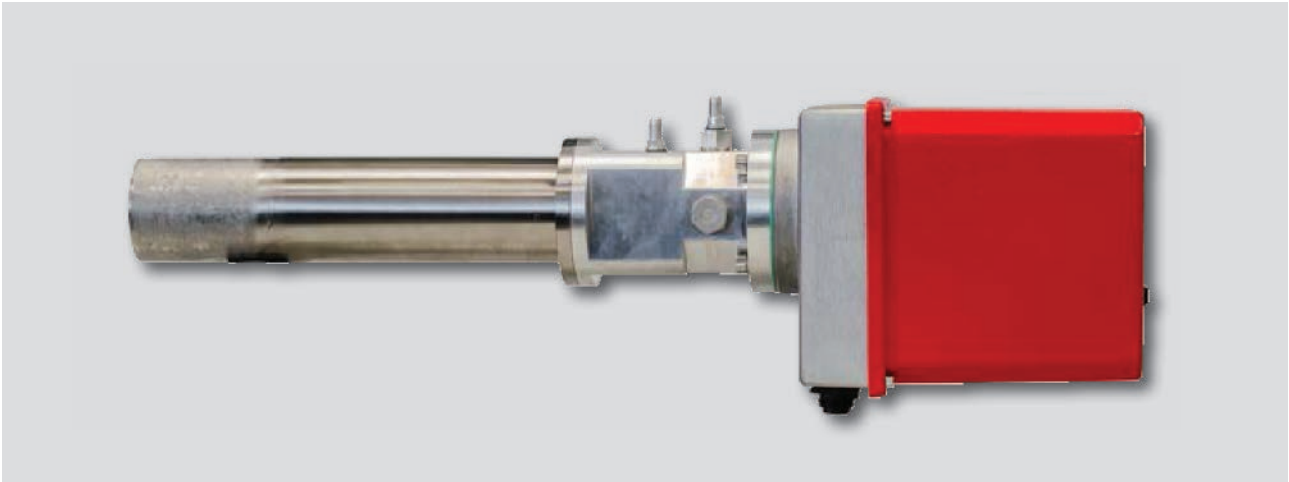

## GFI 70 Set flame quality and flame stability

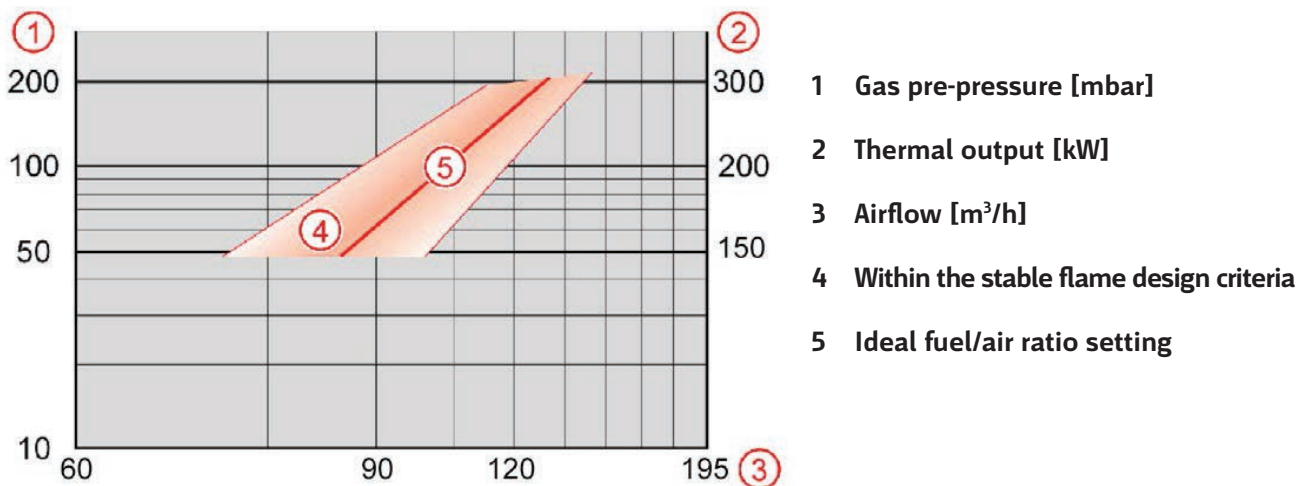

	Standard
Tube diameter	70 mm x 2 mm
Mounting flange	Side flange (e.g. DN 65, PN 6)
Thermal power	150 kW - 300 kW
Flame length	Up to 1,200 mm
Gas connection	3/4" BSPP internal thread
Fuel gas volume flow	30 Nm³/h Natural gas (@ 200 mbar) 12 Nm³/h Propane (@ 200 mbar)
Air connection	1 1/2" BSPP internal thread
Air volume flow	125 Nm³/h (@ 12 mbar) for max. heat release. Lower air flow required if lower gas flow is used. Additional air for stoichiometric combustion has to be available from the combustion chamber.

# GFI 89.



**GFI 89 Set flame quality and flame stability**

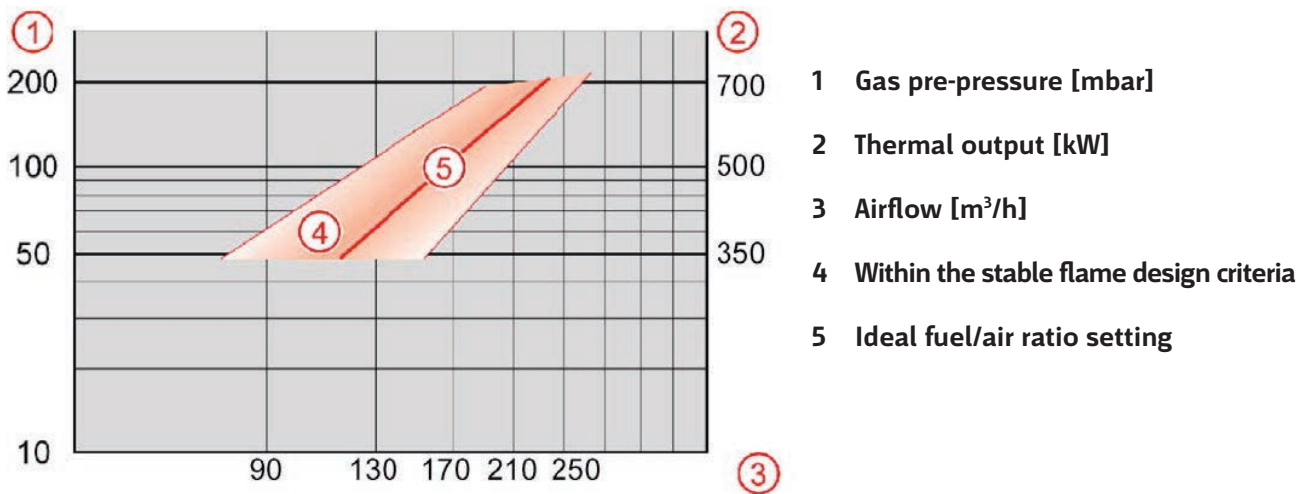

	Standard
Tube diameter	88.9 mm x 2 mm
Mounting flange	Slide flange (e.g. DN 80, PN 6)
Thermal power	400 kW - 700 kW
Flame length	Up to 3,000 mm
Gas connection	1 1/2" BSPP internal thread
Fuel gas volume flow	70 Nm <sup>3</sup> /h Natural gas (@ 200 mbar) 28 Nm <sup>3</sup> /h Propane (@ 200 mbar)
Air connection	2" BSPP internal thread
Air volume flow	250 Nm <sup>3</sup> /h (@ 15 mbar) for max. heat release. Lower air flow required if lower gas flow is used. Additional air for stoichiometric combustion must be available in the combustion chamber

# Technical data.

	Standard
Technical data and features	Gas fired ignitor/pilot burner with integrated high tension transformer, ionisation rod, SIL 3 certified, EN approved, ionisation flame monitor (IFM)
IFM approved for	Continuous operation
Flame response time	≤ 1 s or ≤ 3 s
SIL classification	SIL 3, flame monitor F130I
Flame signal output	Switching contact additional 0-300 mV on measuring sockets for commissioning support intensity display (optional)
Ambient temperature	0 up to + 60 °C
Amplifier	1 potential free NO contact, 230 VAC, 0.5 A
Supply voltage	120 - 127 VAC, 220 - 230 VAC (-15% / +10%), 50/60 Hz
Ignition voltage	8 kV (at U <sub>N</sub> = 230 V), 7kV (at U <sub>N</sub> = 120 V)
Power input	U <sub>N</sub> = 230 V, 230 VA Ignition transformer, ≤ 10 VA flame monitor U <sub>N</sub> = 120 V, 192 VA Ignition transformer, ≤ 10 VA flame monitor
Electrical connection	Plug connection with pre-assembled cable
Cable length	2 - 100 m
IP protection	IP65
Enclosure material (electric)	Aluminium, seawater resistant aluminium (optional)
Tube length	300 - 6,000 mm
Tube material	Stainless steel 1.4301 or 1.4571 optional Heat resistant end tube 1.4841
Fuel gas	Natural gas, butane/propane Coke oven gas and special gases (optional)
Fuel gas supply pressure	50 - 200 mbar (effective)
Air supply pressure	Depending on size
Cooling air flow	Depending on size, at least 50 % combustion air flow

Valid for all versions

# GFI OEM version.





---

**LAMTEC Meß- und Regeltechnik  
für Feuerungen GmbH & Co. KG**

Wiesenstraße 6  
D-69190 Walldorf  
Telefon: +49 (0) 6227 6052-0  
Telefax: +49 (0) 6227 6052-57

[info@lamtec.de](mailto:info@lamtec.de)

[www.lamtec.de](http://www.lamtec.de)

