

ETAMATIC / ETAMATIC S

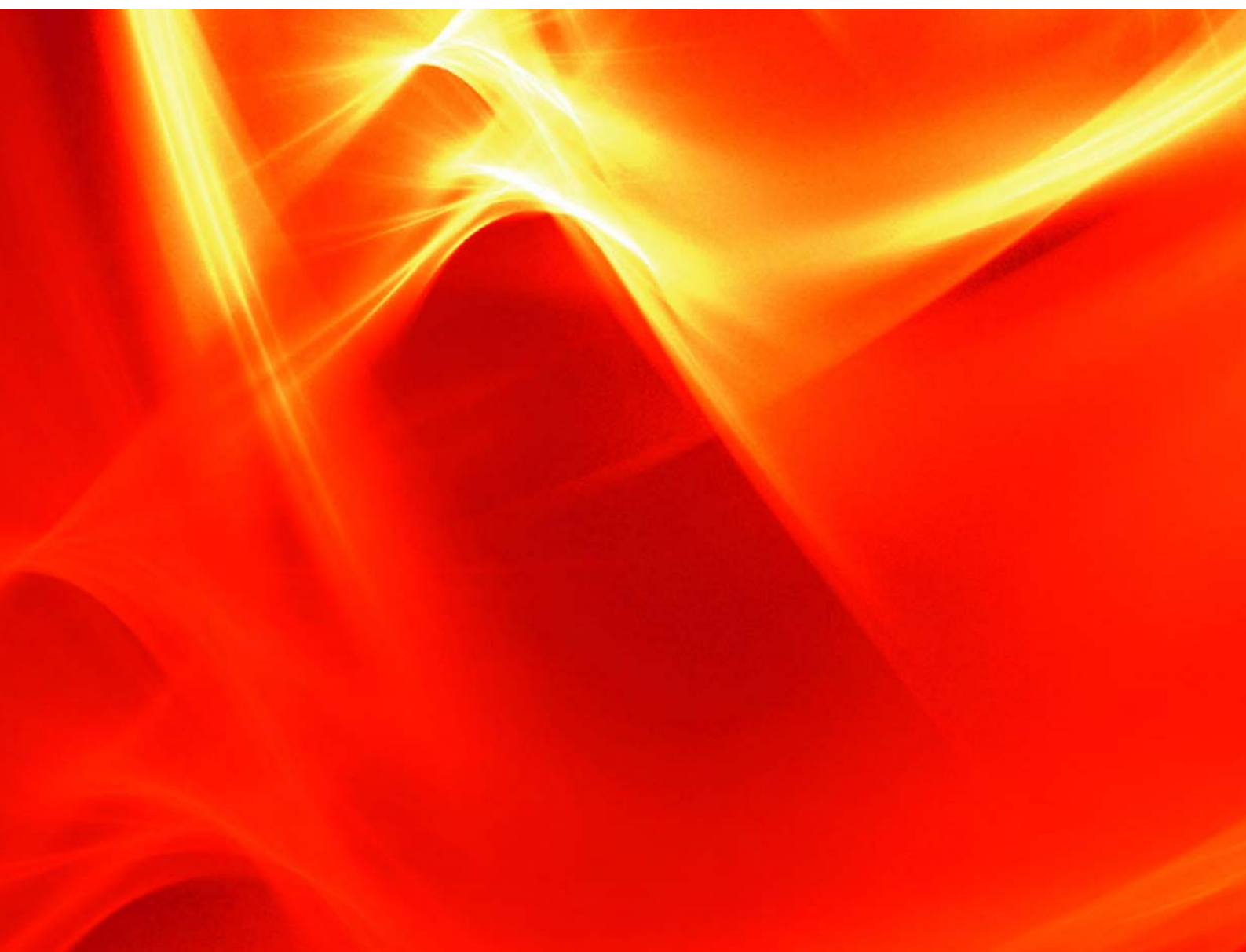

Table of Contents

1	General Information	3
1.1	Validity of these Instructions	3
2	Safety	4
2.1	For Your Safety	4
3	Brief Description	5
4	Operating Description	6
4.1	Starting with Pilot Burner	6
4.2	Starting without Pilot Burner	6
5	Fault	7
5.1	Reading Faults	7
5.2	Resetting Faults	7
5.3	Recalling Fault History	7
6	Operation	8
6.1	CO/O ₂ Control	8
6.1.1	What happens if a fault occurs in the O ₂ trim?	8
6.1.2	Resetting O ₂ Errors	8
6.1.3	Calling Fault History O ₂ trim	9
6.1.4	Calling CO/O ₂ Control Text Messages	9
6.1.5	Display and Interpretation of the Operating Modes	10
6.1.6	Displaying the Running Time Meter	11
6.1.7	Calling the Checksums	12
7	Internal Burner Firing Rate Controller	13
7.1	Purpose	13
7.2	Moving Screen "Actual Temperature is too high"	13
7.3	Changing Setpoint of Burner-Firing-Rate Controller	13
7.4	Manual Control	14
7.5	Meaning of the Display	14
8	Appendix	15
8.1	Mode Abbreviations Used	15
8.2	Fault Codes	16
8.3	Calling Up the Condition of the Digital Inputs	20
8.4	EU Declaration of Conformity	22

1 General Information

1.1 Validity of these Instructions

This manual is valid for the ETAMATIC ETAMATIC S in any configuration.

The content of this document refers to software version v5.8. Other software versions may cause that some of the functions described in this document are not available or have another functionality as described in this document.

These devices conform to the following standards and regulations:

- DIN EN 298: 2012-11
- DIN EN 1643: 2014-09
- DIN EN 13611:2011-12
- DIN EN 60730-2-5: 2015-10
- DIN EN 60730-1:2012-10
- 2014/35/EU Low Voltage Directive
- 2014/30/EU EMC-Directive
- 2014/68/EU Pressure Equipment Directive
- (EU) 2016/426 Gas Appliance Directive
- 2011/65/EU RoHS

Test symbols: CE-0085 AU 0207

The ETAMATIC is a control unit for combustion systems.

NOTICE

Respect the national safety regulations and standards.

2 Safety

2.1 For Your Safety

The following symbols are used in this document to draw the user's attention to important safety information. They are located at points where the information is required. It is essential that the safety information is observed and followed, and that applies particularly to the warnings.

DANGER!

This draws the user's attention to imminent danger. If it is not avoided, it will result in death or very serious injury. The plant including its surroundings could be damaged.

WARNING!

This draws the user's attention to the possibility of imminent danger. If it is not avoided, it may result in death or very serious injury. The plant including its surroundings could be damaged.

CAUTION!

This draws the user's attention to the possibility of imminent danger. If it is not avoided, it may result in minor injuries. The plant including its surroundings could be damaged.

NOTICE

This draws the user's attention to important additional information about the system or system components and offers further tips.

The safety information described above is incorporated into the instructions.

Thus, the operator is requested to:

- 1 Comply with the accident prevention regulations whenever work is being carried out.
- 2 Do everything possible within his control to prevent personal injury and damage to property.

3 Brief Description

The ETAMATIC regulates up to 4 control elements as a function of a control variable, in accordance with freely programmable curves. The ETAMATIC has 4 three-point step control outputs. The ETAMATIC S has 3 three-point step control outputs and one 4-20 mA output.

Examples of possible control elements:

- combustion air damper
- combustion air fan (ETAMATIC S only)
- fuel valve
- recirculation damper

Up to 20 points (usual 11) can be programmed per channel. The Display is relative between 0 and 999.

The ETAMATIC has a 25-pole Sub-D connector with serial interface for remote operation / remote display via a PC (Windows software available separately). Connections for Interbus-S, PROFIBUS-DP, CANopen, TCP/IP (Modbus TCP) and Modbus RTU are available as optional equipment. Other BUS-systems available on enquiry. The connection of other plant components, e.g. fault signal systems and O₂ trim, is via the LAMTEC SYSTEM BUS interface to a 9-pole Sub-D connector.

Operation is via a front panel laminated keyboard. The parameters are displayed on a 2-row LCD screen.

The ETAMATIC continuously monitors its own functions and those of the connected control elements.

230-V outputs:

- Actuation of the gas valves
- Actuation of the oil valves
- Actuation of the oil pump
- Actuation of the ignition valve and the ignition transformer
- Fan release
- Fault message
- Open/Close control signals for the valve/damper motors

External signals to the ETAMATIC are transmitted via floating contacts or chains of contacts.

The following signals can be pre-set:

- 3 separate safety interlock circuits
- fault release
- air pressure monitor
- control release
- min. gas pressure monitor (for valve leakage test)
- flame signal
- ignition position acknowledgement
- re-circulation on
- burner on
- select fuel
- setpoint switching (for firing rate control)

4 Operating Description

A signal is first fed to terminal 58 (Burner On) indicating when the burner is to start. The ETAMATIC then interrogates the boiler safety interlock chain (ETAMATIC) or the common safety interlock chain (ETAMATIC) and the contact of the air pressure monitor. If it does not detect an "OK" condition, the text of a corresponding message appears and the operating control stops.

If all signals are OK, the fan output is activated and the ducts run to their bottom stop as a check.

Once all channels have reached their bottom stop, they open for aeration. The valve leakage test runs in parallel (gas operation only).

In the case of control elements the aeration is used to enter and/or test the range limits. After reaching its top position, the fuel control element runs back into the ignition position. All other channels remain in OPEN position. The ETAMATIC then interrogates the air pressure monitor. If this signal is OK, the parameterised aeration time runs. If a channel is configured for re-circulation, it opens with a time-delay. On reaching the parameterised re-circulation delay time, the aeration time stops. As soon as the re-circulation channel has reached the aeration position, the aeration time is resumed. When this time has expired all the channels run to the programmed ignition position (re-circulation fully closed). After the lapse of the aeration time, all channels run to the programmed ignition position (recirculation closed).

Once all the channels have reached the ignition position the ignition transformer is activated on its own for 3 seconds.

Before the valves open, the respective fuel safety interlock chain has to be closed.

4.1 Starting with Pilot Burner

The ignition valve and main gas 1 (in gas operation) or the ignition valve alone (in oil operation) run open. The pilot flame forms and the flame detection detects the flame. The flame detection sends the signal to the burner control device.

On expiry of the 1st safety time, the ignition transformer switches off. For 3 sec. (stabilisation time) the pilot burner burns alone. Then main gas 2 or the oil valve opens and remains activated in parallel with the ignition valve for the duration of the 2nd safety time. The ignition valve closes again at the end of this period.

3 seconds after ignition, all channels run to the programmed base firing rate point. The ETAMATIC remains in base firing rate position until control release is given.

After control release the ETAMATIC follows the power control unit's default setting.

A shut off follows the cancelling of the signal of the terminal 58. The main valves close. In gas operation, first main gas 1 and second main gas 2 closes with a delay of approx. 5 sec., in order to allow the test line between the solenoid valves to burn out. In the event of a fault shut-down, both close immediately.

If configured for post-purge, the air channels open again for this period.

Thereafter the ETAMATIC is in the "OFF" mode.

4.2 Starting without Pilot Burner

The main valves open and together with the ignition transformer remain activated for the duration of the safety time. During this time the flame signal appears.

5 Fault

5 Fault

5.1 Reading Faults

 Red fault LED is on
Press key 17 to get STATUS → display fault code

 Press key ENTER → Plain text message is shown on display (incl. output of running time counter)

NOTICE

Press key 16 for reading other display values at time of the fault. All display values are frozen.

5.2 Resetting Faults

 press key

5.3 Recalling Fault History



The ETAMATIC stores the last 10 faults with the associated data of the running time counter.
Requirement: ETAMATIC must not be in fault condition.

 Press key 17 until the display shows "Status".

 Press key 3 → the display shows the last fault code

 Press key 11 (Enter) → the display shows the associated plain text and the running time hours.

 Press key 3 again → the display shows the last but one fault code.

  Press keys 3 and 2 to browse through the fault history.

NOTICE

If it is certain that the ETAMATIC has carried a voltage at all times since the last fault, it is possible, that from the present output of the running time counter and the current time, to determine at which time the fault occurred.

6 Operation

6.1 CO/O₂ Control

6.1.1 What happens if a fault occurs in the O₂ trim?

A warning is indicated in case of a fault and the O₂ trim is switched off. The preset values are set anew. The burner would **not** shut-down automatically.

- 1 Fault message is displayed (O₂ controller faulty).
- 2 Explanation text is displayed (e.g. O₂ measuring value faulty).
- 3 Settings of preset basic value without control e.g. for air deficiency.
- 4 Display of running text (O₂ trim faulty)





NOTICE

The display texts are shown every 10 - 15 s alternately. Therefore a keypress to call the explanation text is not necessary.

6.1.2 Resetting O₂ Errors

Each new burner start-up resets O₂ fault automatically. This is permissible, because a 100% O₂ measurement test is performed at each start-up.



Manual resetting of O₂ fault is possible at any time, as follows:

-  Press key RESET
ETAMATIC in O₂ trim mode
-  If not, switch over to O₂ trim mode
Press key 15 M once
-  Press key ENTER and call up the cause of fault (mandatory!)
-  Press key 7

6 Operation

6.1.3 Calling Fault History O₂ trim

 Switch over to fuel/air ratio control mode, if necessary press M.

  Use key 4 and 5 to browse the fault history.

Display:

1	147	1	000 487
current fault	internal firing rate	curve set	operating hours

The display hides the O₂ history automatically after 5 sec. O₂ trim faults, which last for more than 30 sec are stored. They are only stored in the EEPROM once the fault is cleared up or the ETAMATIC leaves the operating mode or control or base firing rate.

6.1.4 Calling CO/O₂ Control Text Messages

Switch display to O₂ trim

 press key "RESET"

 press key M

 press key "ENTER" to call up the text messages

 press key "ENTER" again back

The CO display replaces the O₂ display as soon as CO control is active.

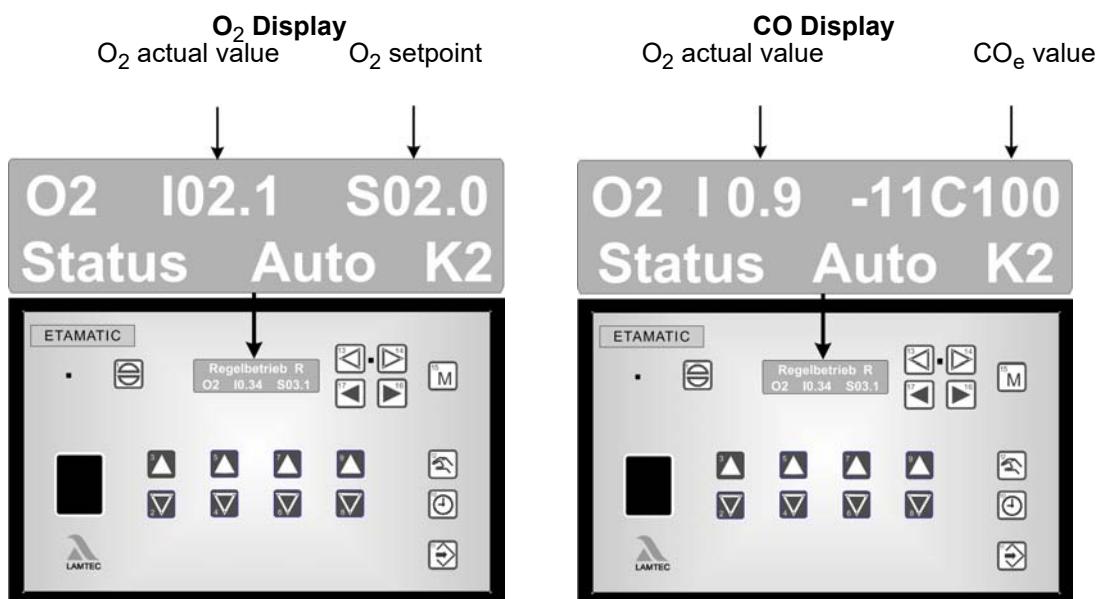

The following additional information would be displayed to the O₂ actual value and CO value:

6 Operation

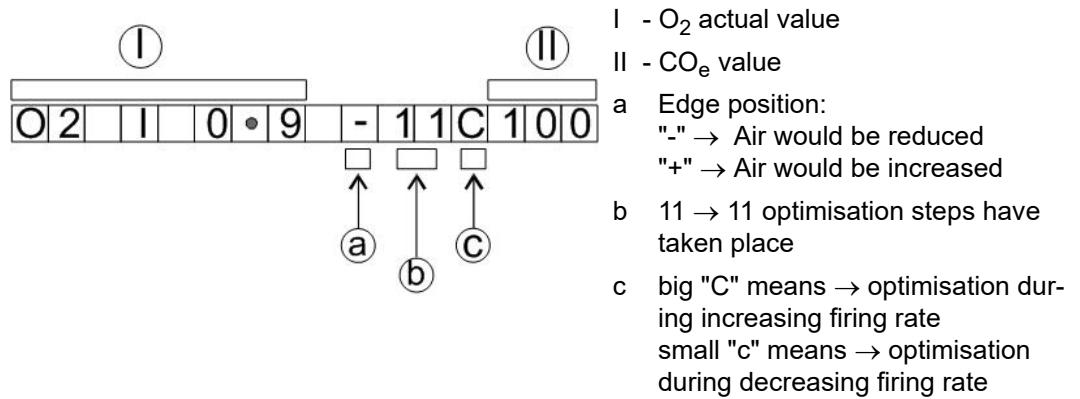

Examples:

02 1 0.7 + 4 c 50

O₂ actual value 0.7 %

+ → air is increased, 4 optimisation steps already performed

c → small "c" means optimisation in the learning curve for decreasing firing rate
 CO_e 50ppm

b- Information on optimisation in the current firing rate segment

"0" → until now there were no optimisation

"1" ... "31" → linear approach

"32" → optimisation completed

"50" ... "81" → successive repeated control from the CO

"D 1" ... "D 6" → dynamic test step 1 to step 6

02 1 3.2 (CO)

Example of inactive control, if the O₂ controller is not permitted to take over.

02 1 0.6 D 2 C 1 2 0

Example of active dynamic test

D2 ... dynamic test active, CO_e 120 ppm

6.1.5 Display and Interpretation of the Operating Modes

op O₂ trim in standby (during burner start-up), or O₂ trim temporarily switched off as a function firing rate via parameters 914 and 915.

or O₂ - trim active.

ot O₂ trim temporarily deactivated (air deficiency, probe dynamics etc).

od O₂ trim deactivated (fault), e.g. test routine failed during burner start-up, dynamic test negative, O₂ trim temporarily deactivated for over 1 hour etc.

C Optimisation at increasing firing rate

- c Optimisation at decreasing firing rate

6.1.6 Displaying the Running Time Meter

 press key 10 → the display shows the running text of the following data successively:

Total running time
Running time on curve set 1
Starts on curve set

Running time on curve set 2
Starts on curve set 2

Running time on curve set 3*
Starts on curve set 3*

Running time on curve set 4*
Starts on curve set 4*



* if parameterised

The total of running times for curve set 1 and curve set 2 do not necessarily add up to the displayed total running time.

NOTICE

The total counter refers to the ETAMATIC 's running time. It starts timing as soon as the unit is connected to a voltage source (this also provides the basis for the fault history). The individual running time counters refer to the burner's running time. They start timing as soon as the burner is in operation with the relevant curve set (flame signal is present).

6.1.7 Calling the Checksums

  Press keys 16 and 17 to select "setpoint feedback".

 Press key 11 ENTER.
The following values are displayed one by one:

CRC 16 of the levels 0, 1 and 2: adjustable at commissioning time
4: adjustable by LAMTEC only

1st safety time oil in seconds

2nd safety time oil in seconds

1st safety time gas in seconds

2nd safety time gas in seconds

pre-purge time in seconds

 Press key 11 ENTER again.

In the ETAMATIC without pilot burner, the 2nd safety time includes the safety time. The 1st safety time figure is then irrelevant.

If you have changed parameters, reset the ETAMATIC. Only a reset refreshes a checksum.

7 Internal Burner Firing Rate Controller

7 Internal Burner Firing Rate Controller

7.1 Purpose

The internal firing rate controller calculates the burner firing rate against a pre-defined setpoint value (e.g. as a function of temperature or pressure) by comparison with the actual value. This position will be transferred to the electronic fuel/air ratio control as a default value.

7.2 Moving Screen "Actual Temperature is too high"



By pressing the HAND key, the ETAMATIC would still starts as long as the maximum temperature is not exceeded.



By pressing the HAND key again, it will change to automatic mode.

7.3 Changing Setpoint of Burner-Firing-Rate Controller

This is only possible when the internal firing-rate controller is active.

With active constant control:



Set the firing rate value with the keys 16 and 17. In the display (left), setpoint 1 or setpoint 2 would be shown, depending on which setpoint is chosen for terminal 50 (0 V for terminal 50 = setpoint 1, 24 V for terminal 50 = setpoint 2)



Press keys 6 and 9 simultaneously, left value blinks in display.



The setpoint can be changed with keys 4 and 5.







Press the Enter key 11 to save the new setpoint.



To end the operating function 'set firing-rate controller' without saving the setpoint, press keys 7 and 8 simultaneously.

7 Internal Burner Firing Rate Controller

7.4 Manual Control

-  Press key MANUAL to move the regular firing rate input of the firing rate controller.
-   Press the keys 2 and 3 to variegate the burner firing rate.
-  Press key MANUAL again to cancel firing rate controller.

It is also possible to switch the ETAMATIC to "Manual Control" with the terminals. By short-circuiting the Pt100 signal (e.g. bridge terminal 19 and 20) the burner firing rate controller is switched off. The fuel/air ratio controller then directly follows the input at the default firing rate input. The display shows LE instead of HA.

NOTICE

Only use manual control while monitoring the system.

7.5 Meaning of the Display

Display in "FIRING RATE" switch position

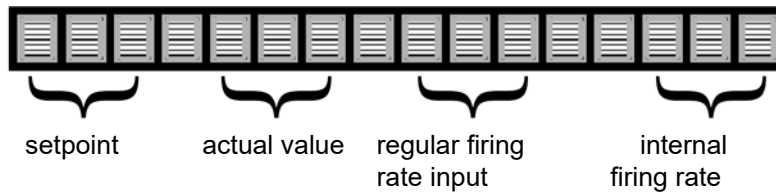

Display in mode "MANUAL"

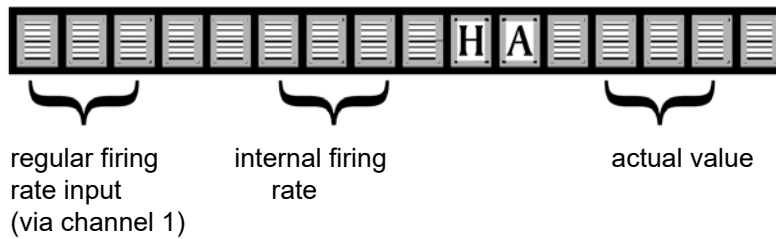

8 Appendix

8.1 Mode Abbreviations Used



Fig. 8-1 Status display at customer interface

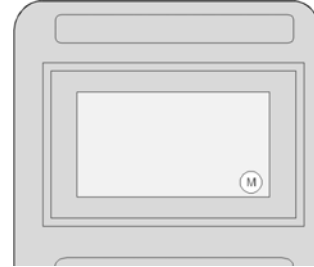

Fig. 8-2 Display at programming unit

Short text	Description
BE	→ READY (signal on terminal 58)
ZÜ	→ IGNITION POSITION or IGNITION
EZ	→ SETTING/IGNITION position (same as IGNITION, but ETAMATIC on SETTING)
GL	→ BASE FIRING RATE
EG	→ SETTING/BASE FIRING RATE" (as BASIC FIRING RATE, but ETAMATIC on SETTING)
NA	→ POST-PURGE
AU	→ BURNER OFF (no signal present)
EL	→ SETTING
SL	→ CLEAR MEMORY
EV	→ SETTING/PRE-PURGE" (as "PRE-PURGE", but ETAMATIC on SETTING)
ES	→ SETTING/CONTROL (as AUTOMATIC but ETAMATIC on SET)
ST	→ FAULT
VO	→ PRE-PURGE
HA or Hand	→ MANUAL MODE (burner efficiency may be adjusted manually)
no display	→ Burner set to AUTOMATIC during OPERATION
LE	→ EXTERNAL FIRING RATE (firing rate controller disabled by digital input)

op O₂ trim in standby (during burner start-up), or O₂ trim temporarily switched off as a function firing rate via parameters 914 and 915.

or O₂ - trim active.

ot O₂ trim temporarily deactivated (air deficiency, probe dynamics etc).

od O₂ trim deactivated (fault), e.g. test routine failed during burner start-up, dynamic test negative, O₂ trim temporarily deactivated for over 1 hour etc.

C Optimisation at increasing firing rate

c Optimisation at decreasing firing rate

8.2 Fault Codes

NOTICE

The LAMTEC burner controls use different methods to detect fault messages between main processor and watchdog processor:

BT300/ETAMATIC/FMS/VMS/FA1:

The bus transmission does not generally use different fault numbers to distinguish between watchdog processor and main processor faults. In order to distinguish the main processor fault messages from the watchdog processor fault messages, an offset of 10000 is added to the watchdog processor faults. The main processor fault message H002 becomes the watchdog processor fault message U10002.

CMS:

CMS allocates different fault numbers to main processor and watchdog processor faults. An offset is not necessary.

Fault Code No.	Restart according to		Description
	TRD	EN676	
001	0	3	Ignition flame does not appear.
002	0	0	parasitic light failure
003	0	3	Flame fault during ignition
004	1	1	Flame fault during operation
005	0	3	Flame signal does not appear during 1st safety time
006	0	3	Flame signal goes out during stabilising time
007	0	3	The flame signal extinguishes during the first safety time
008	0	0	The flame signal extinguishes during the second safety time
009	0	0	Flame signal does not appear during safety time
010	0	0	Flame signal goes out immediately after ignition
141	0	0	Potentiometer faulty, feedback changing too quickly: channel 1
142	0	0	Potentiometer faulty, feedback changing too quickly: channel 2
143	0	0	Potentiometer faulty, feedback changing too quickly: channel 3
144	0	0	Potentiometer faulty, feedback changing too quickly: channel 4
161	>88	3	Monitoring direction of rotation: channel 1
162	>88	3	Monitoring direction of rotation: channel 2
163	>88	3	Monitoring direction of rotation: channel 3
164	>88	3	Monitoring direction of rotation: channel 4
171	>88	3	Dead band over range too long: channel 1
172	>88	3	Dead band over range too long: channel 2
173	>88	3	Dead band over range too long: channel 3
174	>88	3	Dead band over range too long: channel 4
181	>88	3	Dead band under range too long: channel 1
182	>88	3	Dead band under range too long: channel 2
183	>88	3	Dead band under range too long: channel 3
184	>88	3	Dead band under range too long: channel 4
191	1	1	1st monitoring band over range too long: channel 1
192	1	1	1st monitoring band over range too long. Channel: 2

8 Appendix

Fault Code No.	Restart according to		Description
	TRD	EN676	
193	1	1	1st monitoring band over range too long. Channel: 3
194	1	1	1st monitoring band over range too long. Channel: 4
201	1	1	1st monitoring band under range too long. Channel: 1
202	1	1	1st monitoring band under range too long. Channel: 2
203	1	1	1st monitoring band under range too long. Channel: 3
204	1	1	1st monitoring band under range too long. Channel: 4
211	0	0	2nd monitoring band over range too long. Channel: 1
212	0	0	2nd monitoring band over range too long. Channel: 2
213	0	0	2nd monitoring band over range too long. Channel: 3
214	0	0	2nd monitoring band over range too long. Channel: 4
221	0	0	2nd monitoring band under range too long. Channel: 1
222	0	0	2nd monitoring band under range too long. Channel: 2
223	0	0	2nd monitoring band under range too long. Channel: 3
224	0	0	2nd monitoring band under range too long. Channel: 4
231	>88	3	Fuel/air ratio control blocked: channel 1
232	>88	3	Fuel/air ratio control blocked: channel 2
233	>88	3	Fuel/air ratio control blocked: channel 3
234	>88	3	Fuel/air ratio control blocked: channel 4
320	1	1	Broken wire at correction input
321	1	1	Broken wire at feedback channel 1
322	1	1	Broken wire at feedback channel 2
323	1	1	Broken wire at feedback channel 3
324	1	1	Broken wire at feedback channel 4
351	1	1	Different status of ignition position relay
360	0	0	Shut down from O ₂ controller (1) or CO controller (2) :
S362	1	1	Carry out burner servicing
363	1	1	permissible O ₂ value was fallen below
371	0	0	Output for internal firing rate faulty
392	0	0	Remote not responding (time-out)
393	0	0	Remote shut down triggered.
451	1	1	Ignition position was left in ignition mode. Channel: 1
452	1	1	Ignition position was left in ignition mode. Channel: 2
453	1	1	Ignition position was left in ignition mode. Channel: 3
454	1	1	Ignition position was left in ignition mode. Channel: 4
542	0	0	TRIAC selftest : main gas 1 is currentless
543	0	0	TRIAC selftest: main gas 2 is currentless
544	0	0	TRIAC selftest : oil pump is currentless
545	0	0	TRIAC selftest : oil valve is currentless
546	0	0	TRIAC selftest : ignition transformer is currentless
547	0	0	TRIAC selftest : ignition valve is currentless
550	0	0	Oil fuel blocked because a required solenoid valve is not connected
551	0	0	Gas fuel blocked because a required solenoid valve is not connected
600	0	0	Programme check time of sequencer expired.

8 Appendix

Fault Code No.	Restart according to		Description
	TRD	EN676	
601	0	0	Leak check fault: gas pressure still applied.
602	0	0	Leak check fault: gas pressure missing.
603	0	0	Vent gas line manually.
605	>88	3	Oil pressure < min !!!
606	1	1	Gas > min appears in oil operation.
608	0	0	Boiler safety chain dropping.
609	1	1	Gas safety chain dropping.
610	>88	3	Oil safety chain dropping.
611	>88	3	Gas pressure too low
612	1	0	Gas pressure too high.
613	0	0	Air pressure signal missing.
616	1	1	Ignition flame goes out in standby operation
617	1	1	Continuous ignition flame goes out under operation
623	0	0	Atomizer switch-ON-pre-period not kept
624	>88	3	Oil pressure too low
625	>88	3	Oil pressure too high
626	>88	3	Atomizer air pressure too low
702	0	0	Flame signal appears during pre-ventilating.
711	0	0	Illegal operating mode change
713	0	0	Incorrect signal combination in operating mode AU
714	0	0	Incorrect signal combination in operating mode BE
715	0	0	Incorrect signal combination in operating mode VO
716	0	0	Incorrect signal combination in operating mode ZP
717	0	0	Incorrect signal combination in operating mode ZU
719	0	0	Fuel valves open too long without flame
720	0	0	Ignition transformer switched on too long
721	0	0	Ignition valve open too long
723	0	0	Ignition process taking too long
724	0	0	Gas valves open when burning oil
725	0	0	Oil valves open when burning gas
726	0	0	Main gas 2 open without main gas 1
727	0	0	Main gas 1 illegally open
728	0	0	Main gas valves and ignition valve open too long
729	0	0	Ignition process taking too long (without pilot burner)
731	0	0	Ignition valve opened without ignition burner
732	0	0	Incorrect signal combination during operation
733	0	0	Incorrect signal combination after operation
734	0	0	Pre-ventilating time not complied with
736	0	0	Leak check: both gas valves open
737	0	0	Seal tightness check: Main Gas 2 delayed for too long at deactivation.
738	0	0	Leak check: main gas 2 missing
739	0	0	Seal tightness check: Main Gas 2 open for too long.
740	0	0	Seal tightness check: Main Gas 1 leaky.

8 Appendix

Fault Code No.	Restart according to		Description
	TRD	EN676	
741	0	0	Seal tightness check: Main Gas 1 open for too long.
742	0	0	Seal tightness check: Main Gas 2 leaky.
743	0	0	Flame monitoring: flame after-burn too long
744	0	0	Flame monitoring: flame on again
745	0	0	Programme check time exceeded.
747	0	0	Leak check: ventilating into boiler not allowed
750	0	0	Shut-down on faults via bus.
751	>88	3	No data transfer via the bus (time-out).
764	1	1	CO-Controller, internal fault no. -
889	0	0	Time interval between remote-fault-resets is too short.
904	1	1	Error in reference of firing rate
911	1	1	Error in reference, channel: 1
912	1	1	Error in reference, channel: 2
913	1	1	Error in reference, channel: 3
914	1	1	Error in reference, channel: 4
921	0	0	Relay driver self-test : output terminal 11 or 66 (ETAMATIC) faulty.
922	0	0	Relay driver self-test : output terminal 16 or 65 (ETAMATIC) faulty.
923	0	0	Relay driver self-test : output terminal 43 or 68 (ETAMATIC) faulty.
924	0	0	Relay driver self-test : output terminal 67 faulty
925	0	0	Relay driver self-test : output terminal 45 faulty.
926	0	0	Relay driver self-test : output terminal 68 or 61 (ETAMATIC) faulty.
927	0	0	Relay driver self-test : output terminal 36 (ETAMATIC K202) faulty.
929	0	0	Relay driver self-test : output terminal 76 faulty
930	0	0	Relay driver self-test : Output K203 defect.
931	0	0	Relay driver self-test : Output K201 defect.

NOTICE

In case of a fault message occurring which is not mentioned in this fault code list please refer to the burner manufacturer or commissioner of the plant.

8.3 Calling Up the Condition of the Digital Inputs

→ ← press keys 16 and 17 to switch to the digital inputs

Significance of ETAMATIC digital input display

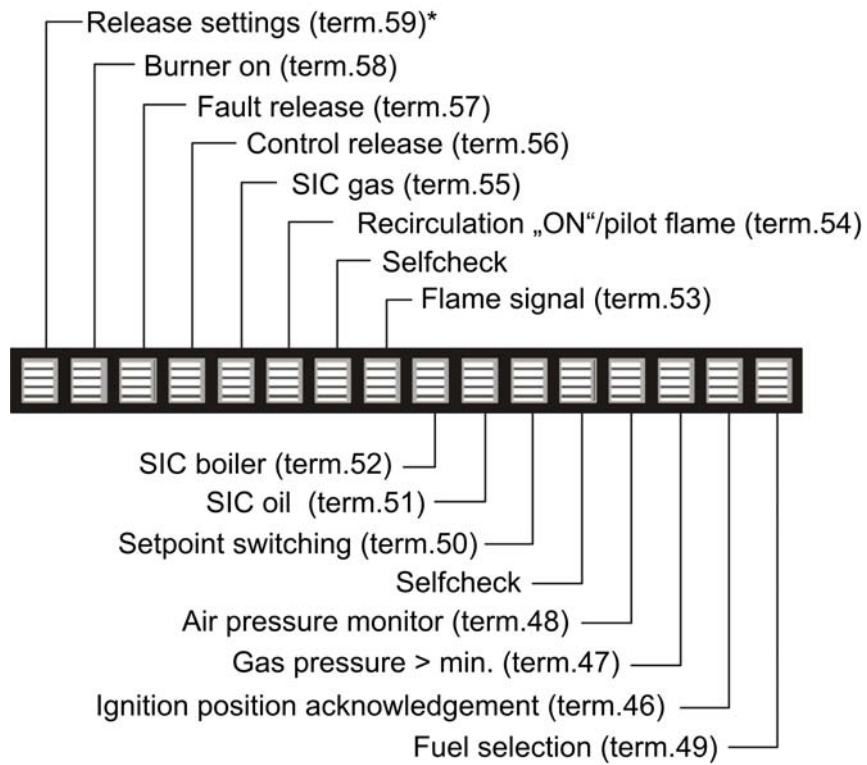

- ↑ = signal is active
- = signal is inactive
- * = only with ETAMATIC without front panel

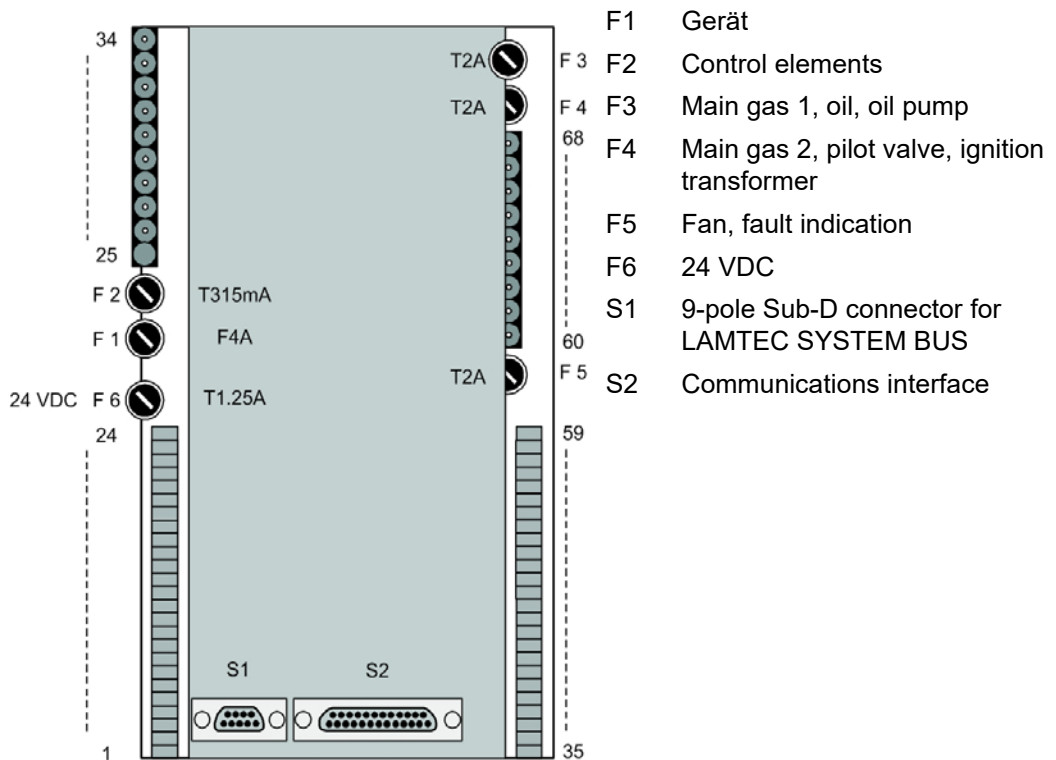

Fig. 8-3 Rear view ETAMATIC

NOTICE

PC connection possible only via LAMTEC interface adapter!

NOTICE

For exchange of the fuses F3, F4, F5 these specifications are to be complied:

- 2A slow blow
- high breaking capacity according to IEC 60127-2, Sheet 5: 1500A @ 250VAC
- melting integral $I^2t < 40 \text{ A}^2\text{s}$
- e.g. Littelfuse 0215002.(M)XP

Fuses which fulfills these requirements are ceramic tube fuses with the label T2AH 250V.

8.4 EU Declaration of Conformity

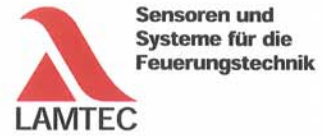

EU-Konformitätserklärung

EU Declaration of Conformity
Déclaration de Conformité UE

Wir (We / Nous)

LAMTEC Meß- und Regeltechnik für Feuerungen GmbH & Co. KG
Wiesenstraße 6
D-69190 Walldorf (Baden)

erklären, dass die
(declare that)
(déclarons que)
inkl.
(inclusive)
(y compris)

ETAMATIC - Brennersteuerung

der Varianten:
(variants, variants)

ETAMATIC
ETAMATIC S
ETAMATIC OEM
ETAMATIC S OEM

dem Erweiterungsmodul:
(additional modules, modules complémentaires)
- Kundeninterface

Produkt-ID-Nummer:
(Product Id Number)
(Numéro d'identification du produit)

ETAMATIC S	663R1
ETAMATIC S OEM	663O1
Kundeninterface	663R0935

auf welche sich diese Erklärung bezieht, mit den folgenden Norm(en) übereinstimmt
(to which this declaration relates conforms to the following standard(s))
(sur laquelle cette déclaration se réfère, et conformément aux dispositions de la norme(s))

DIN EN 298: 2012-11
DIN EN 1643: 2014-09
DIN EN 12067-2: 2004-06
DIN EN 13611: 2011-12
DIN EN 60730-2-5: 2015-10
DIN EN 60730-1: 2012-10

LAMTEC Meß- und Regeltechnik für Feuerungen
GmbH & Co. KG
Wiesenstraße 6
D-69190 Walldorf (Baden)

Telefon: +49 6227 6052-0
Telefax: +49 6227 6052-57

Internet: www.lamtec.de
E-Mail: info@lamtec.de



gemäß den Bestimmungen der folgenden Richtlinie(n).
 (according to the provisions of the following directive(s))
 (conformément aux dispositions de la directive(s))

Nummer (Number / Numéro)	Text (Text / Texte)
2014/35/EU 2014/35/EU 2014/35/UE	Niederspannungsrichtlinie Low Voltage Directive Directive basse tension
2014/30/EU 2014/30/EU 2014/30/UE	EMV-Richtlinie EMC Directive Directive CEM
2014/68/EU 2014/68/EU 2014/68/UE	Druckgeräterichtlinie Kat.4 Mod. B+D Pressure Equipment Directive Directive équipements sous pression
(EU) 2016/426 (EU) 2016/426 (UE) 2016/426	Gasgeräte Verordnung (GAR) Gas Appliance Regulation Règlement appareils à gas
2011/65/EU 2011/65/EU 2011/65/UE	RoHS RoHS RoHS

Die notifizierte Stelle 0085 für (EU) 2016/426, DVGW CERT GmbH, Josef-Wirmer-Str. 1-3, 53123 Bonn, hat folgende Bescheinigung ausgestellt:

EU-Baumusterprüfbescheinigung CE-0085AU0207 gültig bis 05.04.2028.

The notified body 0085 for (EU) 2016/426, DVGW CERT GmbH, Josef-Wirmer-Str. 1-3, 53123 Bonn, Germany, has issued the following certificate:

EU Type Examination Certificate CE-0085AU0207 valid until 05.04.2028.

L'organisme notifié 0085 pour (UE) 2016/426, DVGW CERT GmbH, Josef-Wirmer-Str. 1-3, 53123 Bonn, Allemagne, a délivré le certificat suivant:
 Attestation d'examen de type CE-0085AU0207 valable jusqu'au 05.04.2028.

Die notifizierte Stelle 0036 für 2014/68/EU, TÜV SÜD Industrie Service GmbH, Westendstr. 199, 80686 München, hat folgende Bescheinigung ausgestellt:

EU-Baumusterprüfung (Modul B) Z-IS-TAF-MUC-19-07-2652106-11134230 gültig bis 08.04.2028.

The notified body 0036 for 2014/68/EU, TÜV SÜD Industrie Service GmbH, Westendstr. 199, 80686 Munich, has issued the following certificate:
 EU Type Examination (Module B) Z-IS-TAF-MUC-19-07-2652106-11134230 valid until 08.04.2028.

L'organisme notifié 0036 pour 2014/68/UE, TÜV SÜD Industrie Service GmbH, Westendstr. 199, 80686 Munich, a délivré l'attestation suivante:
 Examen de type UE (module B) Z-IS-TAF-MUC-19-07-2652106-11134230 valable jusqu'au 08.04.2028.

LAMTEC Meß- und Regeltechnik für Feuerungen
 GmbH & Co. KG
 Wiesenstraße 6
 D-69190 Walldorf (Baden)

Telefon: +49 6227 6052-0
 Telefax: +49 6227 6052-57

Internet: www.lamtec.de
 E-Mail: info@lamtec.de



Das Datenblatt und gegebenenfalls die Basisdokumentation sind zu beachten.
(The data sheet and basic documentation, if any, have to be considered)
(La consultation de la fiche technique, et éventuellement de la documentation technique de base, est requise.)

Hinweise zur Anwendung der Richtlinie 2014/35/EU und 2014/30/EU:
Die Konformität mit (EU) 2016/426 setzt die Übereinstimmung mit 2014/35/EU voraus und beinhaltet diese.
Die Konformität mit 2014/30/EU ist nach Einbau des Bauteils in das Endgerät nachzuweisen und zu erklären.

Remarks regarding the application of directive 2014/35/EC and 2014/30/EC:
Conformity with (EU) 2016/426 presupposes that requirements of 2014/35/EC are fulfilled and includes these.
Conformity with 2014/30/EC has to be proved and declared after installation of the component.

Remarques sur l'application des directives 2014/35/EC et 2014/30/EC:
La conformité avec la (UE) 2016/426 intègre la conformité avec la 2014/35/EC.
La conformité avec la 2014/30/EC après l'installation de l'appareil est à prouver et à déclarer.

Rechtsverbindliche Unterschrift
(Authorised signature) (Signature autorisée)

LAMTEC Meß- und Regeltechnik für Feuerungen
GmbH & Co. KG
Wiesenstraße 6
D-69190 Walldorf (Baden)

Walldorf, 28.01.2020
Dr. Olaf Winne, Geschäftsführung

Telefon: +49 6227 6052-0
Telefax: +49 6227 6052-57

Internet: www.lamtec.de
E-Mail: info@lamtec.de

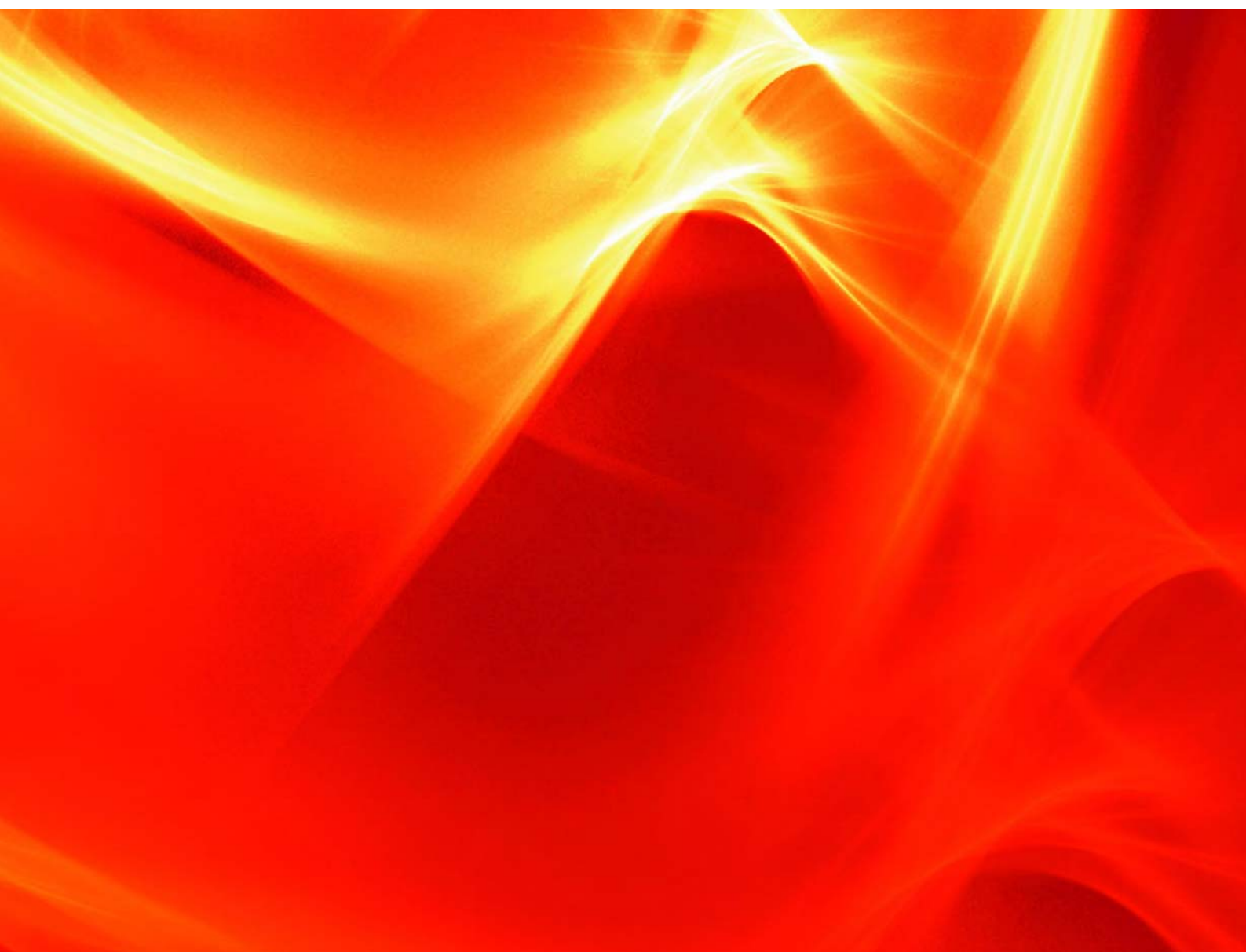

The information in this publication is subject to technical changes.



**LAMTEC Meß- und Regeltechnik
für Feuerungen GmbH & Co. KG**

Wiesenstraße 6
D-69190 Walldorf
Telefon: +49 (0) 6227 6052-0
Telefax: +49 (0) 6227 6052-57

info@lamtec.de
www.lamtec.de

