



System overview

Lambda Transmitter LT2, LT2-K
Lambda Probe LS2, LS2-K
Combination Probe KS1D, KS1D-K



Sensors and systems for combustion engineering

www.lamtec.de

LAMTEC's LT2 family of Lambda Transmitters: a modular O₂ and CO/O₂ measuring system for all applications.

LAMTEC supplies leading technology for measuring exhaust gas in combustion systems. Our comprehensive portfolio of O₂ and CO/H₂ probes, along with transducers, can be combined to meet specific requirements and integrated easily into control systems. You get precisely what you need for your combustion system: a solution that both meets your requirements and fits your budget.

LAMTEC offers the LT2 Lambda Transmitter in two basic versions. As a measuring device for O₂ only, the LT2 Lambda Transmitter is combined with the LS2 Lambda Probe. It can also be combined with the KS1D Combination Probe. In this case, it can be used to measure both O₂ and oxidisable emissions (CO_e = CO equivalent).

Since the LT2 Lambda Transmitter system is modular by design, the different sensors can be combined with the various valves and fittings with ease. The advantage of this is that the system can be adapted to perform a variety of measuring tasks.



A direct connection between the LT2 Lambda Transmitter and the LAMTEC VMS4/VMS5 fuel/air ratio control management system, the LAMTEC FMS4/FMS5 combustion management system, the LAMTEC ETAMATIC and Burner Tronic BT300 burner controls provides the basis for innovative control processes to optimise oil and gas combustion and for the automatic adaptation combustion systems to changes in combustion conditions.

In addition to O₂ measurement, the Lambda Transmitter supports the following functions when combined with LAMTEC combination probes:

- Measurement of flue gas and suction air temperatures and calculation of combustion efficiency
- Detection of unburned components (CO/H₂), displayed as CO equivalent (CO_e)
- Calculation and display of CO₂ concentration
- Firing rate-dependent and fuel-specific limit curves/limit values
- Integrated PID/O₂ controller
- Fieldbus connection

- Advantages:
- Direct (in situ) measurement of oxygen (O_2) and oxidising exhaust gas components (CO/H_2) in the raw gas up to a temperature of 1,200 °C O_2 measurement, range 0 to 21 vol. % CO_e measurement, range 0 to 10,000 ppm
- Not affected by false air (CO_e)
- No gas preparation required, measurement is taken directly in the moist flue gas
- Response time set to 60 % (T60) $O_2 < 10$ seconds with standard extraction $CO_e \leq 2$ seconds
- Low heating power 20 to 25 W depending on the exhaust gas temperature
- Certified flame arrestor
- Universally compatible
- Easy to use - plug-in probe connection
- Low maintenance

Measurement principle

Sensor technology principle for the O_2 electrode:

The LAMTEC KS1D Combination Probe is based on a heated electrochemical measuring cell made from zirconium dioxide ceramic (ZrO_2).

It has 3 electrodes:

- O_2 electrode (platinum)
- CO_e electrode (platinum/noble metal)
- Reference electrode (platinum)

The probe is a zirconium dioxide ceramic tube that is sealed on one side. It protrudes into combustion system's emissions channel and divides the reference gas compartment (surrounding area) from the measuring gas compartment (emissions channel) so that no gas can escape. The reference electrode is located on the inner side of the zirconium dioxide ceramic in the reference gas compartment. The two measuring electrodes for O_2 and CO/H_2 are located on the outer side of the ceramic in the measuring gas compartment. An integrated heater warms the probe to a temperature of around 650 °C and controls this temperature. At this temperature, the zirconium dioxide ceramic conducts oxygen ions and the two sensor signal voltages U_{O_2} (between the reference and O_2 electrodes) and U_{CO_e} (between the reference and CO_e electrodes) form accordingly and can be measured.

The sensor voltage U_{O_2} [mV] corresponds to the known Nernst voltage, which is dependent on the sensor temperature T [K] and on the logarithm for the O_2 partial pressure ratio between the reference and measuring chambers, with the constants $k = 0.21543$ [mV/K] and the sensor-specific offset voltage U_0 [mV]. as per the formula: $U_{O_2} = U_0 + kT \ln(p_{O_2,ref}/p_{O_2,meas})$.

U_0 is determined by calibrating the probe with the ambient air: With $p_{O_2,ref} = p_{O_2,meas} = 0.21$, the last part of the equation becomes zero and the offset voltage is measured $U_0 = U_{O_2}$ at 21 vol.% O_2 . A typical Nernst O_2 characteristic (U_{O_2}) at a typical sensor temperature $T = 923^\circ$ [K] with a typical offset voltage of $U_0 = -5$ [mV] is shown in "Nernst sensor characteristic $U_s = f(O_2)$ ".

Sensor technology principle for the CO_e electrode:

The CO_e electrode is identical to the O_2 electrode apart from the fact that the electro-chemical and catalytic properties in the signal materials are different, thus enabling combustible components such as CO , H_2 , to be detected.

For "clean" combustion, the Nernst voltage U_{O_2} also forms on the CO_e electrode and the characteristics of both electrodes follow an identical path. In the event of incomplete combustion and in the presence of combustible components, a non-Nernst voltage U_{CO_e} also forms on the CO electrode and the characteristics for both electrodes move apart (see "Typical signal characteristics for the two KS1D sensor voltages").

The total sensor signal U_{CO/H_2} on the CO_e electrode is made up of the total of these two voltages: $U_{CO/H_2} = U_{O_2} + U_{CO_e}$. If the oxygen content - measured by the O_2 electrode - is deducted from the total sensor signal, the result $U_{CO_e} = U_{CO/H_2} - U_{O_2}$ can be used to generate the concentration of combustible components CO_e in ppm. The "Typical signal characteristics" for the two KS1D sensor voltages shows the typical path for CO_e concentrations (dashed line) when O_2 content reduces gradually. When moving into the deficient air range, the CO_e concentration increases significantly at the so-called emission edge as a result of the poor/incomplete combustion caused by insufficient air for combustion. The resulting signal characteristics U_{O_2} (continuous line) and U_{CO/H_2} (dotted dashed line) for the KS1D are also shown. In the excess air range with clean CO_e free combustion, the two sensor signals U_{O_2} and U_{CO/H_2} are identical to one another and show the current oxygen content in the exhaust gas channel in accordance with the Nernst principle. Close to the emission edge, the sensor signal for the CO_e electrode U_{CO/H_2} increases at a disproportionate rate due to the additional non-Nernst CO_e signal.

The typical signal characteristics for the two KS1D sensor voltages U_{O_2} and U_{CO/H_2} in relation to the O_2 content in the emissions channel. The typical characteristic of combustible components CO_e is also shown.

In addition to the absolute sensor signals U_{CO/H_2} and U_{O_2} , the relative change to the sensor signals after time dU_{O_2}/dt and $dU_{CO/H_2}/dt$ and, in particular, the signal dynamic range for the CO_e electrode can also be used to determine the emission edge (see "Dynamic range of the CO_e electrode signal U_{CO/H_2} in the incomplete combustion range").

Basic system.



LT2 in IP65 wall-mounting housing.



LT2K with integrated reference air pump.

The LT2 Lambda Transmitter is available in two basic versions:

- Sheet steel housing, lockable door at the front, impact-resistant inspection window, optional display and control unit IP65.
- Sheet steel housing, lockable door at the front, impact-resistant inspection window, with integrated reference air pump, optional display and control unit IP65.

Probes.

In situ, LAMTEC probes support both O₂ measurement (LS2 Lambda Probe) and simultaneous measurement (KS1D Combination Probe) of O₂ concentration and combustible oxidising gas components (CO/H₂), displayed as CO_e (CO equivalent).

Lambda Probe LS2 Combination Probe KS1D



Properties:

- Measurements are taken directly in the moist flue gas up to 300 °C
- Protection rating IP42, the probe must be protected against water, snow, etc., if installed outside

Applications:

- Natural gas, heating oil (extra light).

Lambda Probe LS2 in a housing with the GED and PIF Combination Probe KS1D in a housing with the GED and PIF

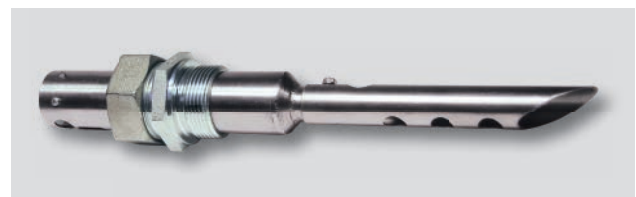

GED = Gas extraction device
PIF = Probe installation fitting

Properties:

- Measurements are taken directly in the moist flue gas up to 300 °C
- Protection rating IP42, the probe must be protected against water, snow, etc., if installed outside

Applications:

- Natural gas, heating oil (extra light).

Lambda Probe LS2 in HT design
Combination Probe KS1D in HT design



Properties:

- Measurements are taken directly in the moist flue gas up to 1,200 °C
- Option for semi-automatic calibration during operation with test gas
- IP65 protection rating

Applications:

- Natural gas, heating oil (extra-light), coal, particle-laden fuel emissions (available with optional de-dusting cleaning).

Lambda Probe LS2-K or LS2-KR
Combination Probe KS1D-K or Combination Probe KS1D-KR

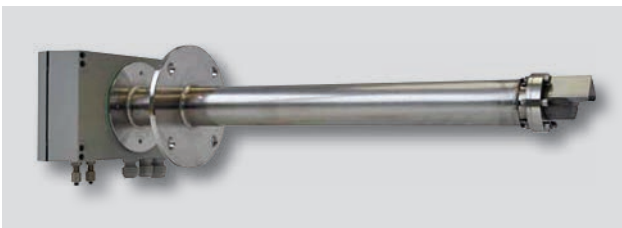

Properties:

- Measurements are taken directly in the moist flue gas up to 450 °C
- On-site customer reference air connection (instrument air); alternatively, an integrated reference air pump can be supplied
- Option for semi-automatic calibration during operation with test gas backflushing supported, cyclic regeneration of measuring cell with air
- IP65 protection rating

Applications:

- Natural gas, domestic fuel (extra-light), heating oil (heavy), biomass, non-standard fuels

Lambda Probe LS2-KH with protective tube
Combination Probe KS1D-KH with protective tube



Properties:

- Measurements are taken directly in the moist flue gas up to 450 °C
- On-site customer reference air connection (instrument air)
- Option for semi-automatic calibration during operation with test gas
- IP65 protection rating
- Includes protective tube for high dust

Applications:

- Natural gas, domestic fuel (extra-light), heating oil (heavy), coal, biomass, particle-laden fuel emissions, non-standard fuels

Lambda probe LS2 and combination probe KS1D with flue gas extraction tube

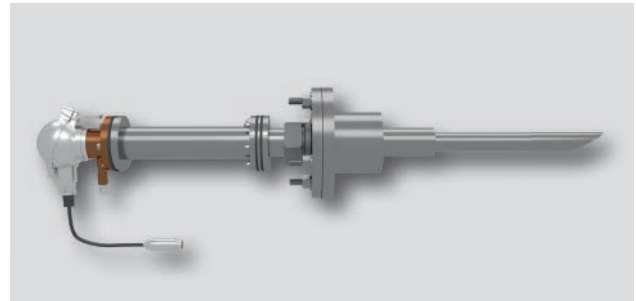

Properties:

- Measurements are taken directly in the moist flue gas up to 1,200 °C
- Option for semi-automatic calibration during operation with test gas
- IP65 protection rating

Applications:

- Natural gas, heating oil EL, HFO, special gases

Lambda probe LS2 and combination probe KS1D with flue gas extraction tube and T-adapter

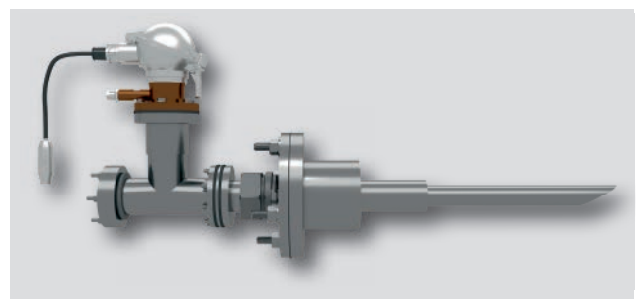

Properties:

- High exhaust gas temperatures up to 1400°C
- T-adapter to protect the probe

Applications:

- Dusty and other special fuels

**Lambda Probe LS2-KAF with purging clean and filter mesh
Combination Probe KS1D-KAF with purging and filter mesh**

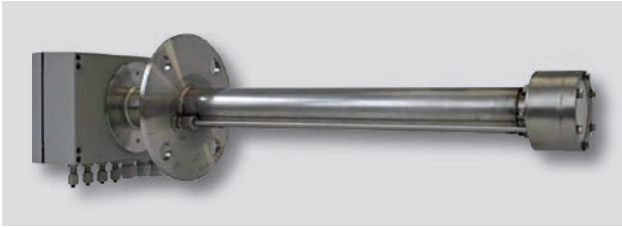

Properties:

- Measurements are taken directly in the moist flue gas up to 200 °C
- On-site customer reference air connection (instrument air)
- Option for semi-automatic calibration during operation with test gas
- IP65 protection rating
- Includes protective tube for high dust with purging pre-filter and additional filter mesh

Applications:

- Natural gas, domestic fuel (extra-light), heating oil (heavy), coal dust combustion, biomass, fuel emissions with high dust content, non-standard fuels

**Lambda Probe LS2-KA with purging
Combination Probe KS1D-KA with purging**



Properties:

- Measurements are taken directly in the moist flue gas up to 450 °C
- On-site customer reference air connection (instrument air)
- Option for semi-automatic calibration during operation with test gas
- IP65 protection rating
- Includes protective tube for high dust with purging pre-filter

Applications:

- Natural gas, domestic fuel (extra-light), heating oil (heavy), coal, biomass, particle-laden fuel emissions, non-standard fuels

**Lambda Probe LS2-EX / IIB
Combination Probe KS1D-EX / IIB**

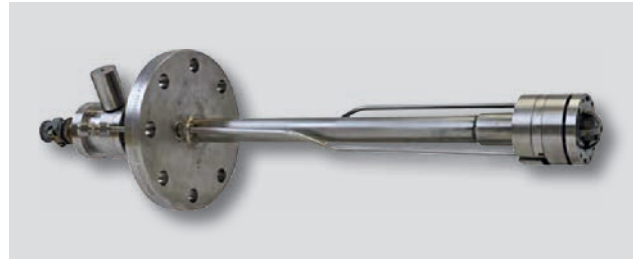

Properties:

- Measurements are taken directly in the moist flue gas up to 500 °C
- On-site customer reference air connection (instrument air)
- Option for semi-automatic calibration during operation with test gas
- IP65 protection rating
- Includes ATEX certification: II 2G EEx D IIB +H2T3, Zone 1.

Applications:

- Natural gas, domestic fuel (extra-light), heating oil (heavy), coal, non-standard fuels

**Lambda Probe LS2 for manual purging
Combination Probe KS1D for manual purging**

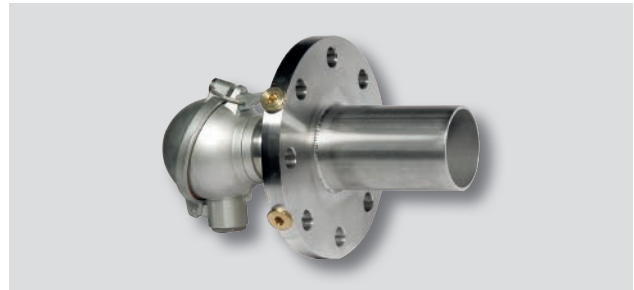

Properties:

- Measurements are taken directly in the moist flue gas up to 600 °C
- Includes fitting for manual purging
- IP65 protection rating

Applications:

- Measurement of very high exhaust gas temperatures. Fuels: Natural gas, domestic fuel (extra-light), heating oil (heavy), coal, biomass, non-standard fuels

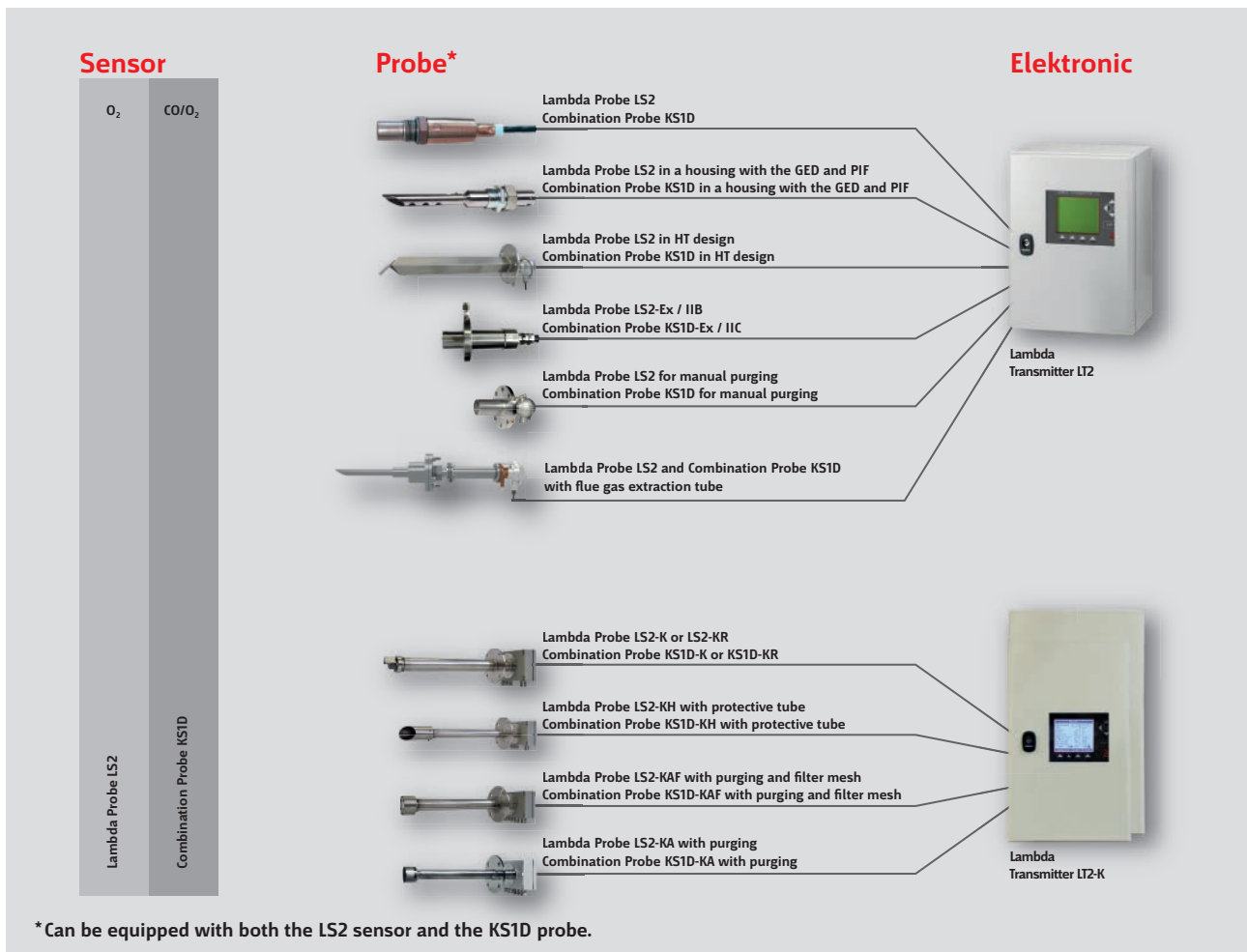

Functions in the LT2 with KS1D/LS2.

Optional components.

- Display and control unit
- Remote display software
- Measurement of flue gas and suction air temperatures and calculation of combustion efficiency
- Calculation and display of CO₂ concentration, calculated for specific fuel from the O₂ measured value and the CO₂ max. value
- Firing rate-dependent and fuel-specific limit values/limit curves
- Integrated PID-O₂ controller
- 4 floating analogue outputs (output 1 and 2) max. voltage difference 20 V can be set to any value, direct current 0/4 to 20 mA, firing rate impedance 0 to 600 Ohm
- 6 digital outputs in connection with relay module 657R0857
- Fieldbus connection
- Housing heating
- Purge unit

Options for LAMTEC probes

- Semi-automatic calibration (available for probes with attribute "K")
- Fully automatic calibration (available for probes with attribute "KV")
- Reference air pump (available for probes with attribute "K" and "Ex")
- Purge unit with an exhaust gas deflection pipe (available for probes with attribute "HT")
- Purging the pre-filter (available for KS1D-KA, LS2-KA, KS1D-KAF and LS2-KAF)
- Automatic regeneration of ZrO₂ measuring cell with short application of air for biomass

Accessories

- Mating flange
- Flange seal
- Probes in various lengths

Inputs.

Outputs.

